

Recommended PCB Layout

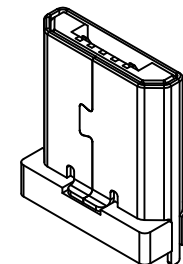

Isometric View

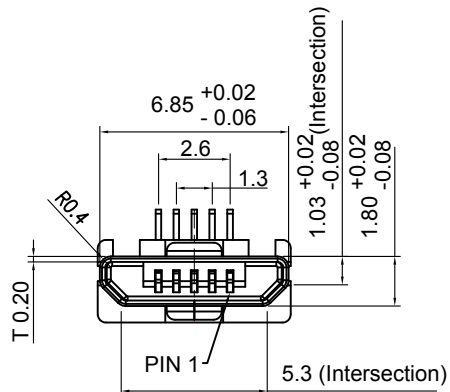
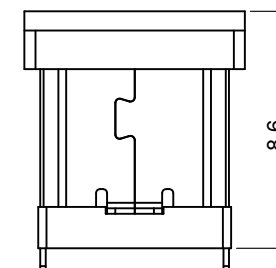

With Cap

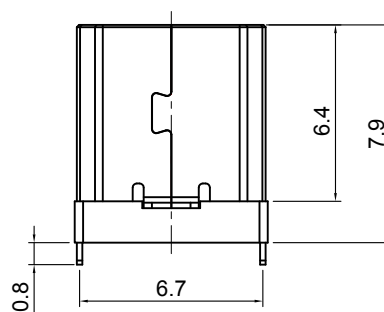
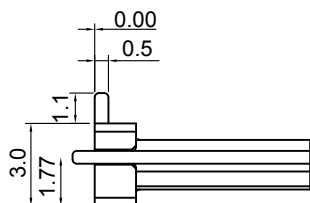
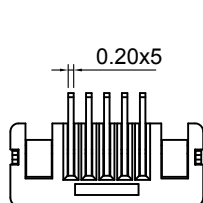

ELECTRICAL:

VOLTAGE RATING: 5V AC
 CURRENT RATING: 1.5 AMP
 DIELECTRIC STRENGTH: 100V AC
 INSULATION RESISTANCE: 100 MΩ Min.
 CONTACT RESISTANCE: 30 mΩ Max.

MATERIALS:

HOUSING: High Temperature Thermoplastic, UL94-VO
 COLOR: Black
 CONTACTS: Copper Alloy
 SHELL: Stainless Steel
 TEMPERATURE RANGE: -20°C to +85°C

HOW TO ORDER:

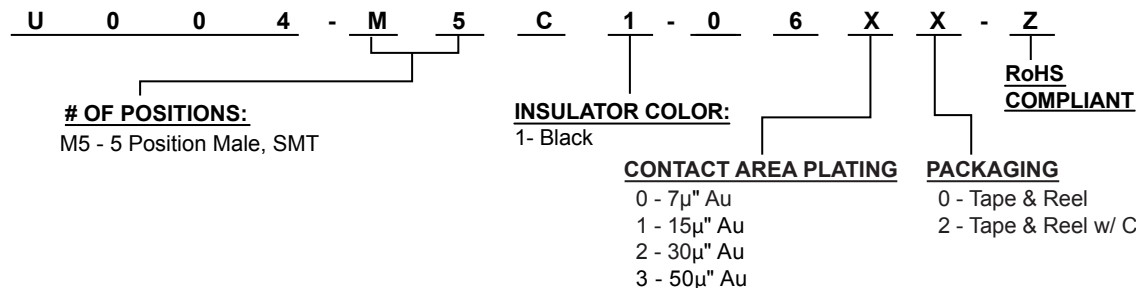

Rev	Drawn	Checked	Approved	Date
0	B.S.	S.M.	S.M.	12/08/14

SMP TECHNOLOGY, INC.

Micro USB 2.0, 5 Position, Male header, Surface Mount,

PC Tail w/ Thru Hole Mounting Peg

Tolerance : Dimension .X +/- 0.20 .XX +/- 0.10 .XXX +/- 0.05

SERIES: U004-M5C1-06XX-Z