

SHELL SIZE

CONTACT ARRANGEMENT

09



2WK2 (MALE)



2WK2 (FEMALE)



2W2



5W1

15



3WK3 (FEMALE)



3WK3 (MALE)



3W3



7W2



11W1

25



5W5

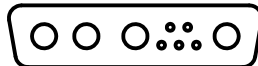

9W4

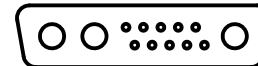

13W3

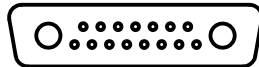

17W2



21W1

37



8W8



13W6

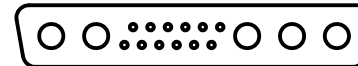

17W5

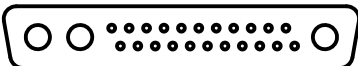

25W3

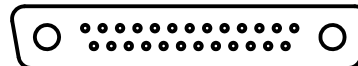

27W2

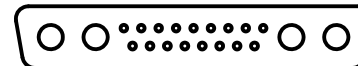

21W4

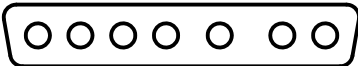

7W7

50

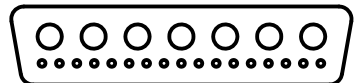

24W7

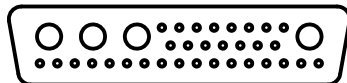

36W4

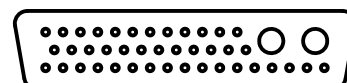

43W2

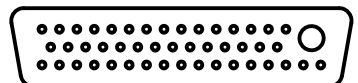

47W1

Footprint (I)	J
9.4	2.54
7.2	2.84

SHELL 09



SHELL 15

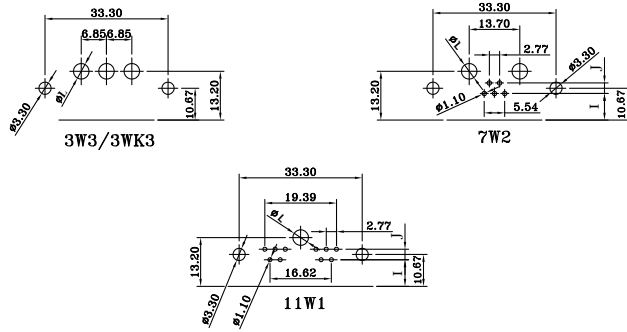

SHELL 25

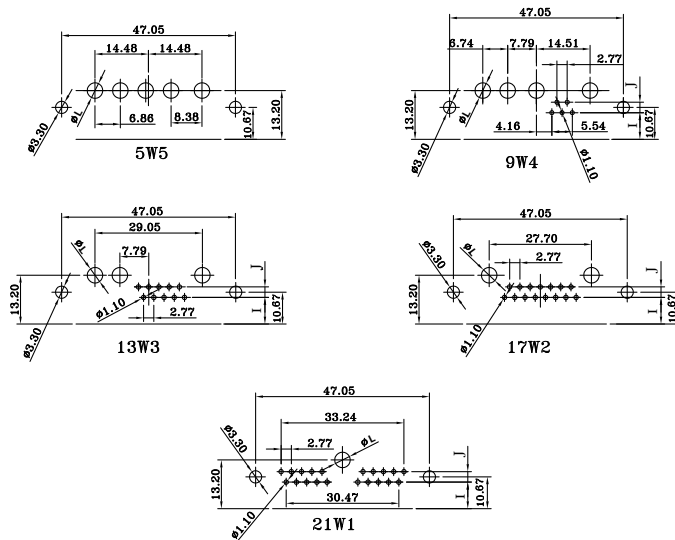

SHELL 37

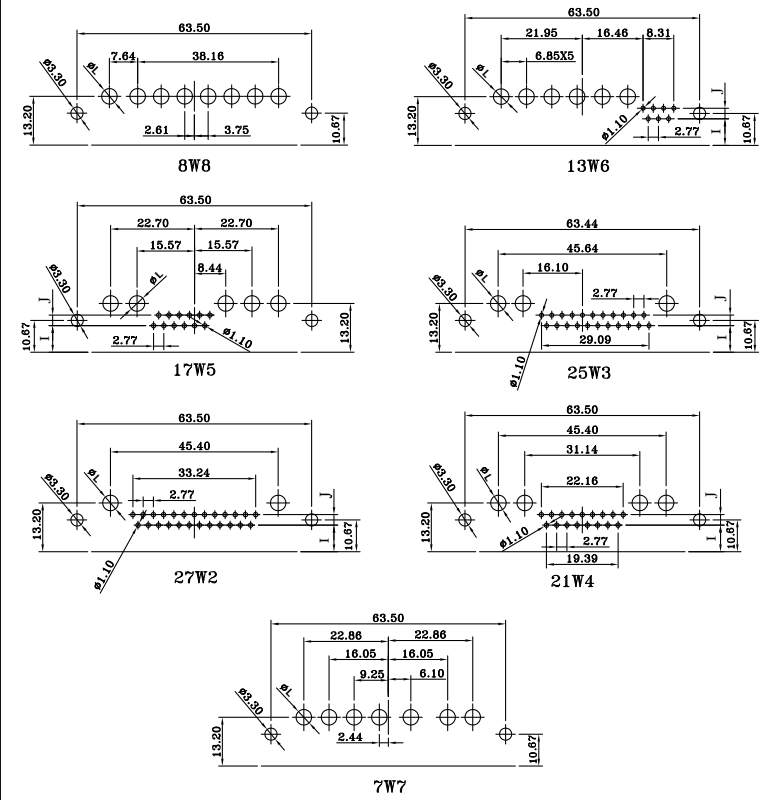

SHELL 50

